



FUSION[®]

**Hotel guest room management system
with on line electronic lock**

FEATURES

INDEX

GRMS WITH ONLINE ELECTRONIC LOCK	4
THINK GREEN	5
STANDARD CONFIGURATIONS	6
GENERAL WIRING DIAGRAM	7
FEATURES CHART	8
FEATURES DETAILS	8
ELECTRONIC HOTEL LOCK	9
TOUCH PANELS	10
Corridor service panel with room number	10
Corridor service panel	10
Card holder / reader	11
Card reader	11
Climate control panel	12
Bedside panel	12
PRESENCE DETECTION SENSORS	13
Motion detector	13
Magnetic switch	13
SOFTWARE DEVICE	13
Card coder	13
CERTIFICATIONS	14

GRMS WITH ONLINE ELECTRONIC LOCK



GUEST ROOM
MANAGEMENT
SYSTEM



FUSION®



ELECTRONIC
LOCK

FUSION® is the perfect integration between **TECHOTEL TH3®** one of the most advanced Guest Room Management System (GRMS) made by **TECNOVOX®** and **Opera Bit®** a very innovative Electronic Lock by **AGB**.

The deep collaboration between these two highly specialized and experienced Italian companies, has resulted in a system ideal for hotel, combining security and total control, maximizing operational efficiency.

THINK GREEN



FUSION®



THINK GREEN

Taking care of energy means saving the environment.



SAVE MONEY

Save money limiting energy consumption and reducing technical devices stress.



INCREASE SECURITY

Room and common areas access with highly innovative and secure On Line Electronic Lock, real time controlled.



CONTROL

All functions of rooms and common areas real time controlled.

A change of 1 degree in the room saves 3% of the energy bill of the HVAC system.

STANDARD CONFIGURATIONS

- 1. STARTER EDITION (SE)
- 2. LIGHT EDITION (LE)
- 3. FULL EDITION (FE)
- 4. FULL EDITION (FE) + MOTION SENSOR

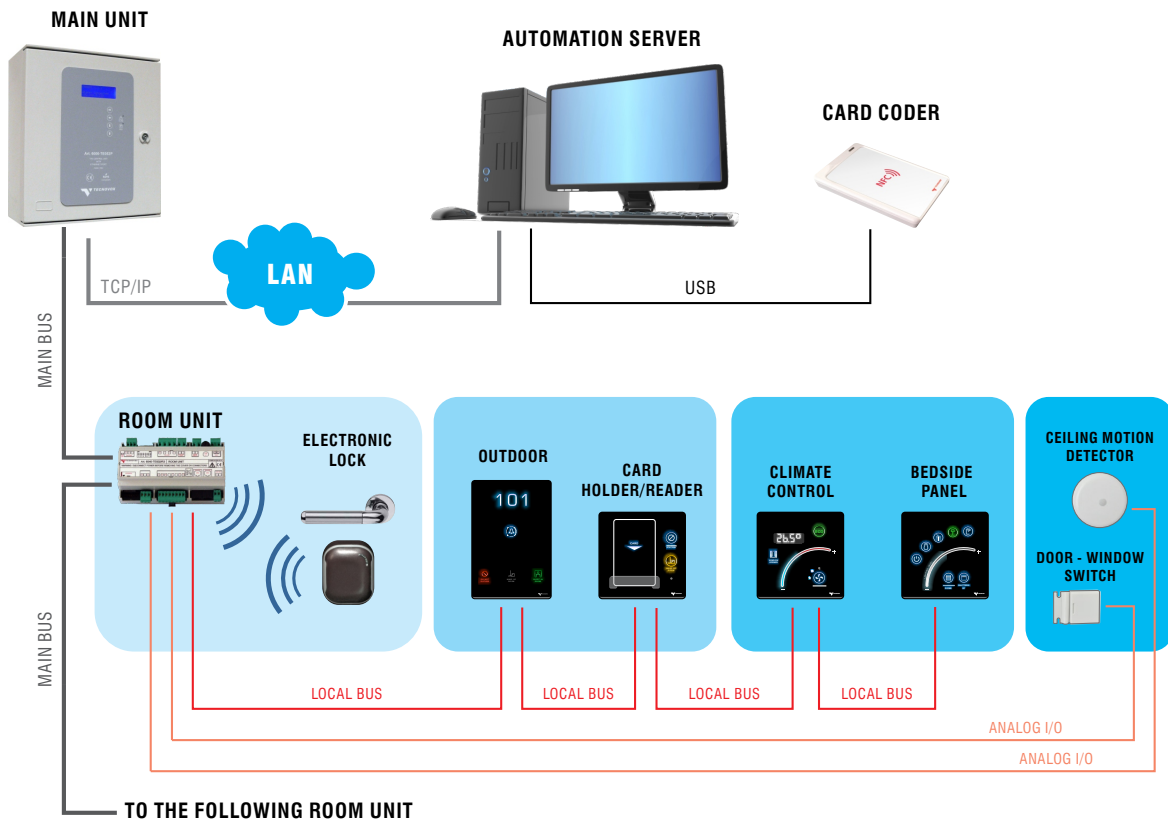

DESCRIPTION

- The automation server will be connected to one or more Main Units via Ethernet
- Each Main Unit will be connected with its Room Unit via main bus
- Each Room Unit will be connected wireless to its electronic lock
- Each Room Unit will be connected with its room panels via local bus

GENERAL WIRING DIAGRAM

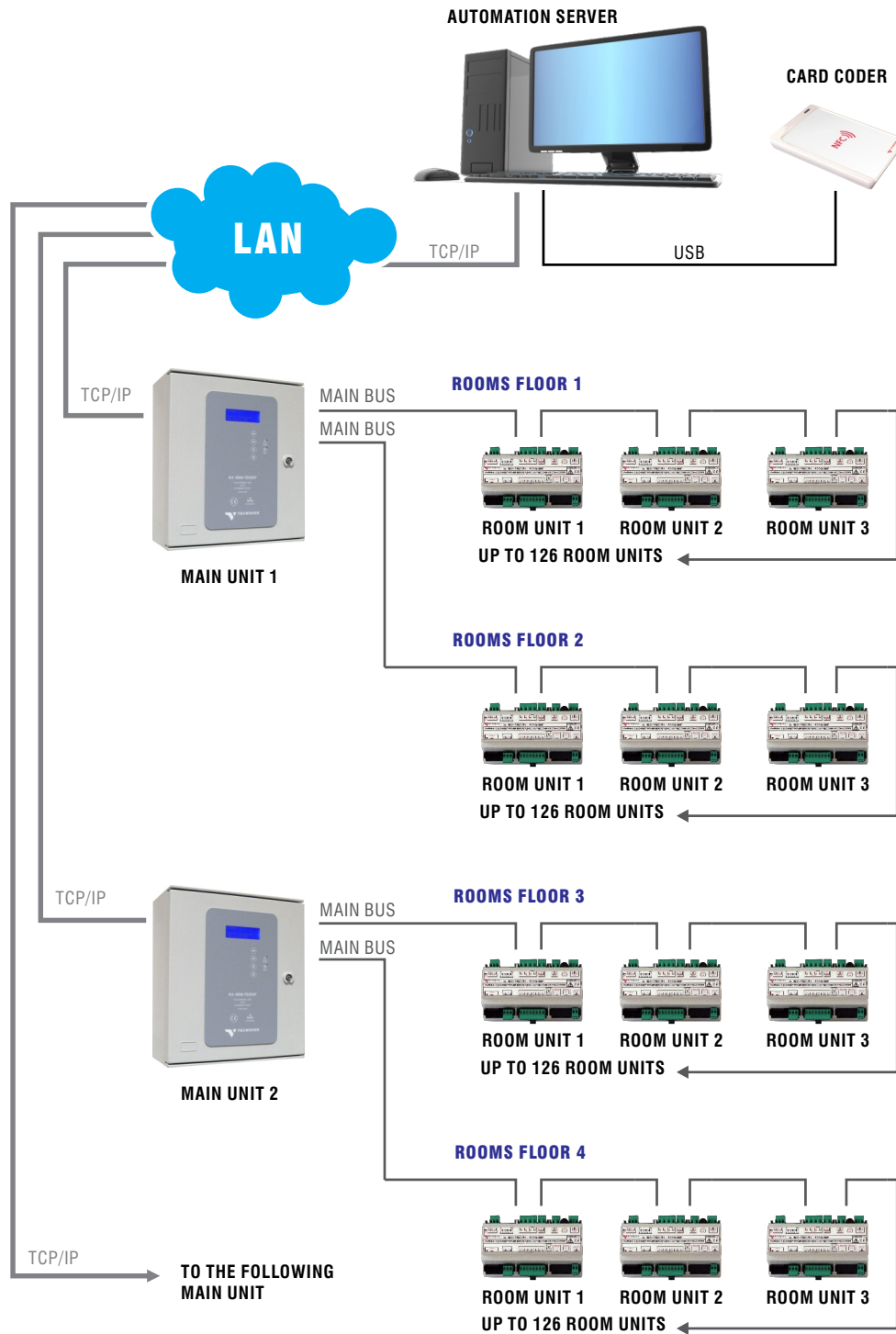

DESCRIPTION

- The Automation Server will be connected via Ethernet to one or more Main Units
- Each Main Unit will be connected via Daisy Chain bus with its Room Units
- Daisy Chain connections reduces greatly the cables and facilitates the installation

FEATURES CHART

FEATURES	STARTER EDITION (SE)	LIGHT EDITION (LE)	FULL EDITION (FE)
PMS & RMS INTERFACE	●	●	●
ALARM	●	●	●
ACCESS	●	●	●
GUEST PRESENCE DETECTION		●	●
ELECTRICITY CONTROL AND ENERGY SAVING		●	●
CORRIDOR SERVICE ANNUNCIATOR		●	●
ROOM SERVICE SIGNAL ACTIVATION		●	●
ROOM STATUS			●
TEMPERATURE CONTROL AND ENERGY SAVING			●

FEATURES DETAILS

PMS & BMS INTERFACE

- Authorized and certified interface with the most common PMS including Micros®, Fidelio®, Opera®
- Possibility of RMS interface via Modbus or TCP/IP (Custom made)

ALARMS

- Bathroom help alarm pull cord
- Bathroom flood detection
- Intrusion alarm

ACCESS

- Opening code, stored in the main room unit and wireless transferred to the electronic lock
- Using Mifare RFID card. NFC ready
- Security electronic lock with mechanical emergency key and magnetic latch
- Access report archive
- Room move without keycard change
- Keycard replacement for loss or theft with automatic cancellation of the previous
- Easy guest extended stay without keycard involvement
- Door half open control
- Low battery warning at workstations

GUEST PRESENCE DETECTION

- By intelligent card holder
- By any kind of motion detectors properly combined with door contact

ELECTRICITY CONTROL AND ENERGY SAVING

- Programmed welcome entry light or light scene
- Switching off electricity with unsold room or guest absent
- Scene lights control

CORRIDOR SERVICE ANNUNCIATOR

- Installed in the corridor aside the room entry door
- Including lighting signals: Do not disturb, Make up room, Guest presence, Call button

ROOM SERVICE SIGNAL ACTIVATION

- Lighting buttons included in the card holder: Do not disturb, Make up room, chime
- Lighting buttons included in the bedside panel: Do not disturb, Make up room
- Do not disturb function by the button located at the room side of the electronic lock

ROOM STATUS

- To be cleaned. Signal automatically set on occupied rooms
- Cleaning in progress
- Ready for inspection
- Room cleaned
- Room free
- Room occupied
- Room out of order
- Event report archives

TEMPERATURE CONTROL AND ENERGY SAVING

- Summer / winter switching
- 2 or 4 pipes climate control
- Room real temperature indication on site and at workstations
- Basic temperature for unsold rooms automatically set
- Stand-by temperature set for occupied rooms but guest absent
- Comfor temperature set with manual adjustment (limited range) when guest is inside the room
- Fan coil local control or VRV/VRF systems interface
- Temperature time programming for rooms
- Temperature control and programming for common areas

ELECTRONIC HOTEL LOCK



A unique electronic lock for hotels designed by **AGB, Alban Giacomo Spa**, with magnetic movement, designed to blend with the internal door that creates new silence standard when door closes.

Twin lock, and automatic latch closing system, protects the security of your room. The magnetic latch **1** comes out when the sash leans against the frame and the automatic bolt **2** is activated ensuring the maximum antiburglar security.

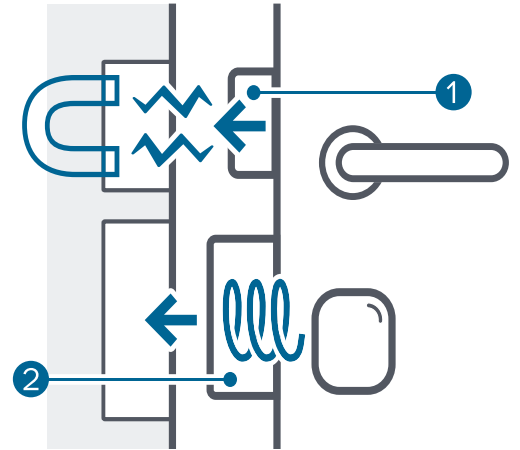

FEATURES:

- RFID electronic lock, NFC ready
- Advanced technology
- Wireless connected to Main Room Unit of the GRMS
- Magnetic automatic bolt ensuring the maximum security
- Emergency mechanical half cylinder
- Shockproof, antiburglar strength
- Antipanic function, unblocking the bolt and the latch simultaneously by internal handle



FEATURES:

- Innovative and minimal design, thanks to the small reader and the battery holder
- The personalisation of the cover finish let the designer creativity free
- The possibility to choose the handle gives more chance to the door designer: Opera Bit blends with every design style

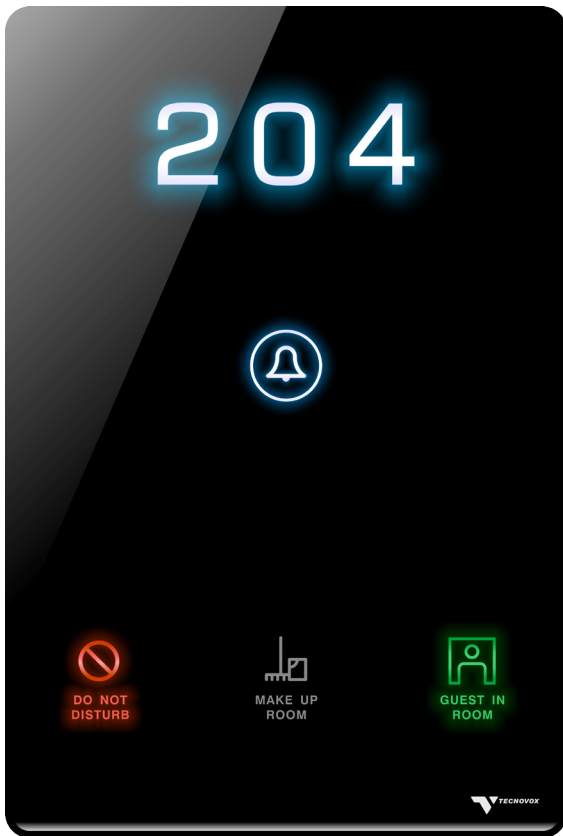

Corridor service panel with room number

- Backlighting with wave effect

Features:

- Doorbell button
- Room number with customized letter fonts
- Hotel logo (upon request)

Icons:

- Do Not Disturb
- Make Up Room
- Guest in room



Corridor service panel

Format:

- 114 x 114 mm

Features:

- Doorbell button

Icons:

- Do Not Disturb
- Make Up Room
- Guest in room



Card holder / reader

- Room card reader holder and reader for energy control and room status

Features:

- When a card is inserted, it enables the electricity and switches the temperature to the guest-in preset point. The room status is visualized through front or back office workstation.

Commands:

- Do Not Disturb
- Make Up room

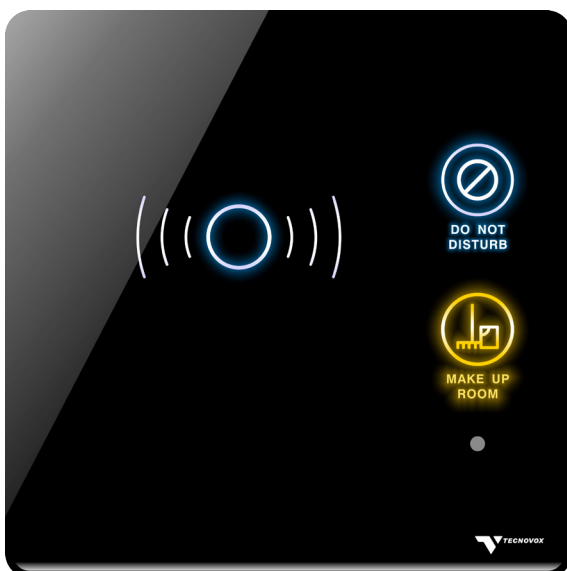

Card reader

- Room card reader for room status report by the staff, approaching its card and pushing the related button

Features:

- The room status is visualized through front or back office workstation
- Including chime

Commands:

- Do Not Disturb
- Make Up room



Climate control panel

- Room temperature measurement and display

Features:

- Capacitive touch panel
- Window opened icon

Commands:

- Eco command
- Fan speed
- Temperature adjustment slide bow



Bedside panel

- To control up to 4 lights

Features:

- Capacitive touch panel for on/off or dimmed lights

Commands:

- Selection of 4 light with related icons
- Touch dimming slide bow
- All-off, in one touch
- Door-Opening (Or on request: Shutters down)
- Do Not Disturb (Or on request: Shutters up)

PRESENCE DETECTION SENSORS



Motion detector

Features:

- PIR analog wired motion detector - 360° sensitivity range
- Ceiling mounted



Magnetic switch

Features:

- Wired magnetic switch

SOFTWARE DEVICE



Card coder

Features:

- RFID Mifare card coder
- Connected via USB to workstation

CERTIFICATIONS

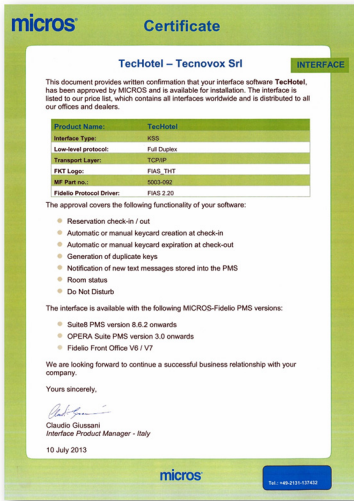

TecHotel Micros Compatibility

Authorised and certified
interface with Micros® PMS



TECNOVOX Srl CE Conformity

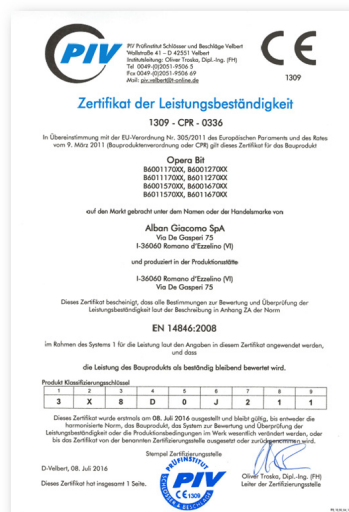

Alban Giacomo Spa CE Conformity

In conformity with:
EN 14846:2008

Product classification:
3X8D0J211

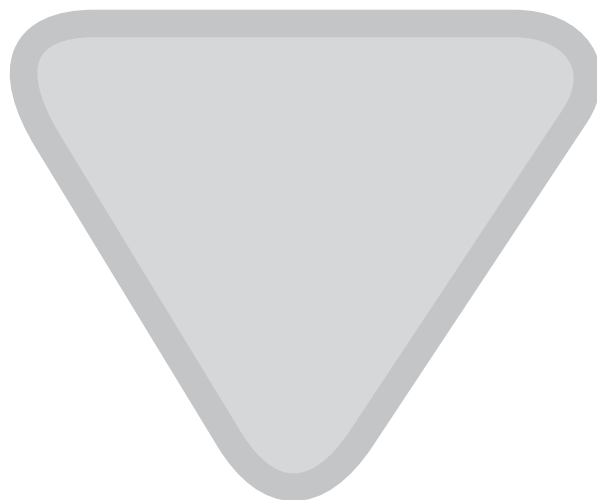

Head Office: Piazza Basile 46 - 15121 Alessandria - ITALY
Legal Office: Via Ruffini 2/a - 00195 Roma - ITALY
EMEA Sales Office: Piazzale Brescia 6 - 20149 Milano - ITALY
Tel. +39 0131 445036 - Fax +39 0131 264737
www.tecnovox.it - info@tecnovox.it

TECNOVOX GHS - DMCC
GLOBAL HOSPITALITY SOLUTIONS

Jumeirah Lakes Towers - Unit 1201 at Fortune Tower - Dubai - U.A.E.
Tel. +971 56 221 1617
www.tecnovox.it - info@tecnovoxinternational.com



Alban Giacomo spa
Via A. De Gasperi 75,
36060 Romano d'Ezzelino (VI) - Italy
Tel. +39 0424 832832
www.agb.it - info@agb.it